

sistema modulare
modular system
modulsystem
système modulaire
sistema modular

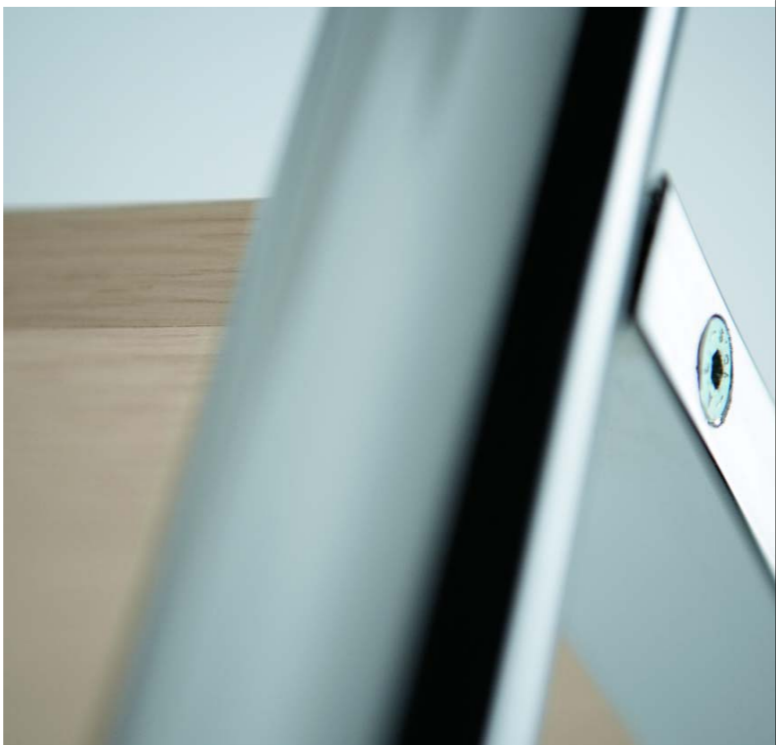

rondò

i plus di rondò

added features for rondò / Die Pluspunkte von Rondò / les atouts de rondò / las ventajas de rondò

Uno stile dinamico attuale per la moda contemporanea

Up-to-date dynamic style for contemporary trends
Ein aktueller und dynamischer Stil für die Mode der Gegenwart
Un style dynamique actuel pour la mode contemporaine
Un estilo dinámico actual para la moda contemporánea



Dettagli di design distinguono le nuove emozioni

Design details for striking new sensations
Designdetails kennzeichnen neue Emotionen
Des détails de design distinguant les nouvelles émotions
Detalles de diseño que distinguen las nuevas emociones

sistema flat

imballo compatto e costi di trasporto ridotti

flat system compact packaging and minimised transport costs / Flat-System kompakte Verpackung und reduzierte Transportkosten
système flat emballage compact et frais de transport réduits / sistema plano embalaje compacto y costes de transporte reducidos

È un sistema estremamente intelligente che permette di ridurre al minimo le dimensioni della struttura imballata, garantendo la protezione dei componenti ed una notevole riduzione dei costi di trasporto.

This extremely clever system minimises the dimensions of the packed item, ensuring protection for components and considerably lower transport costs.

Ein sehr intelligentes System, das die Ausmaße der verpackten Struktur so klein wie möglich macht und den Schutz der Komponenten und eine starke Reduzierung der Transportkosten garantiert.

Il s'agit d'un système très intelligent qui permet de réduire les dimensions de la structure emballée au minimum, en garantissant la protection des composants et une réduction considérable des frais de transport.

Es un sistema extremadamente inteligente que permite reducir al mínimo las dimensiones de su estructura embalada, garantizando la protección de los componentes y una notable reducción de los costos de transporte.

Il sistema modulare Rondò è stato appositamente progettato per rendere le operazioni di montaggio estremamente facili e veloci anche a persone non specializzate.

The Rondò modular system has been specifically designed to make assembly operations extremely quick and easy, even for non-specialized persons.

Das modulare System Rondò wurde speziell entwickelt, um die Montagearbeiten auch für Personen, die keine Fachleute sind, besonders einfach und schnell zu gestalten.

Le système modulaire Rondò a été spécialement conçu pour rendre les opérations de montage extrêmement faciles et rapides, même pour les personnes qui ne sont pas spécialisées.

El sistema modular Rondò ha sido especialmente estudiado para hacer que las operaciones de montaje sean extremadamente fáciles y rápidas incluso para personas no especializadas.

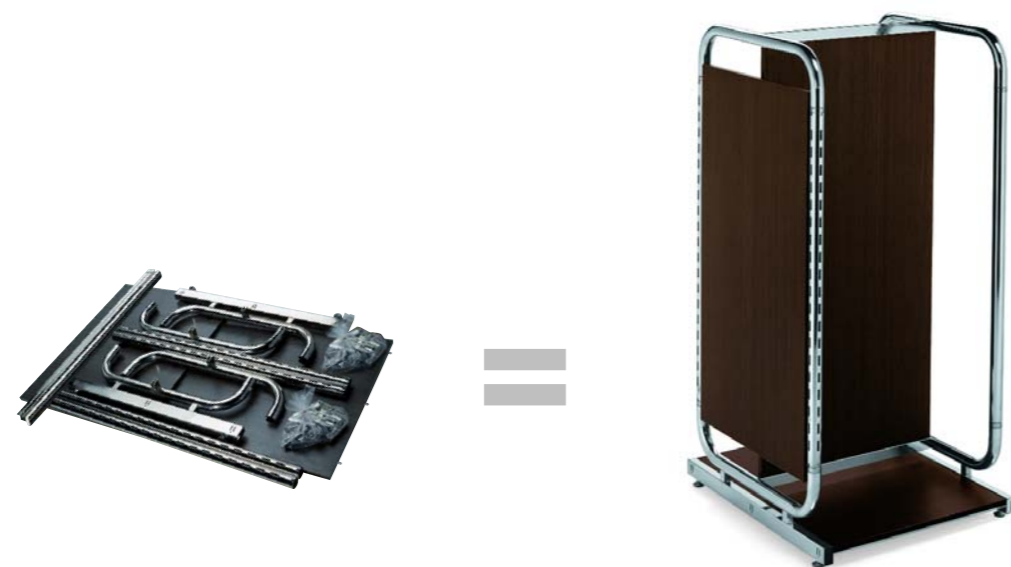



Rondò, realizzato in tubo tondo, si contraddistingue per le sue linee curve ed armoniose che si ispirano ad uno stile retrò degli anni '70. È un sistema modulare che con la sua flessibilità permette realizzazioni di grande creatività ed originalità, espressione delle tendenze di mercato e del design italiano.

Rondò, made of round tube, is featured by harmonious and curved lines and inspired to the old '70. It is a flexible modular system that allows implementations of great creativity and originality, expressing the market trends and Italian design.

Rondò aus Rundrohr zeichnet sich durch die kurvig und harmonischen Formen aus, die sich am Retro-Look der 70er-Jahre inspirieren. Es handelt sich hier um ein Modulsystem, mit dem sich durch seine Flexibilität höchst kreative und originelle Lösungen realisieren lassen, die Ausdruck der Markttendenzen und des italienischen Designs sind.

Rondò, réalisée en tube rond, se distingue par ses lignes courbes et harmonieuses qui s'inspirent à un style retrò des années '70. C'est un système modulaire qui, avec sa flexibilité, permet des réalisations de grande créativité et originalité, expression des tendances du marché et du design italien.

Rondò, realizado en tubo redondo, se caracteriza por las líneas curvas y armoniosas que se inspiran en el estilo «retrò» de los años '70. Es un sistema modular que con su flexibilidad permite realizaciones de gran creatividad y originalidad, expresión de las tendencias del mercado y del diseño italiano.



pareti attrezzate

wall system units / Wandstrukturen / systèmes murales / paredes equipadas

36



gondole

gondolas / Gondeln / gondoles / góndolas

38



accessori per pareti attrezzate e gondole

accessories for wall system and gondola / Zubehör für Wandstruktur und Gondel
accessoires pour système murale et gondole / accesorios para paredes y góndolas

42



stender Rondò

Rondò rail / Rondò Ständer / penderie Rondò / perchero Rondò

46



accessori stender

Rondò rail accessories / Zubehör für Rondò Ständer
accessoires penderie Rondò / accesorios perchero Rondò

47



gondolina Rondò

Gondolina Rondò / Gondolina Rondò / Gondolina Rondò / Gondolina Rondò

48



accessori gondolina

Gondolina rail accessories / Zubehör für Gondolina Ständer
accessoires penderie Gondolina / accesorios perchero Gondolina

49



banco espositivo

display table / Vorlagentisch / comptoir / mostrador

52



seduta in ecopelle

stool, synthetic leather / Hocker aus synthetischem Leder / tabouret en cuir / taburete simil piel

53



tavolini

display tables / Vorlagentische / tables de présentation / mesas de exposición

54

Struttura

Structure / Struktur / Structure / Estructura

CODICE	▲	A	B	C	p
RO40240	CL	-	249	-	5
RO40244	GA	-	249	-	5

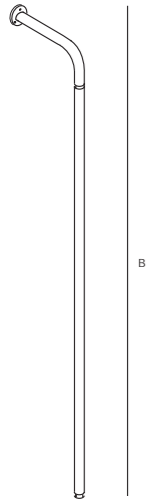

Montante ad "L" per parete attrezzata

L-upright for wall system unit
L-Säule für Wandstruktur
Montant a "L" pour système murale
Montante a "L" para pared equipada



Distanziatore per parete attrezzata

Spacer for wall system unit
Abstandstück für Wandstruktur
Fixation murale réglable
Separador para pared equipada

CODICE	▲	A	B	C	p
RO25200	CL	30	-	-	-
RO25204	GA	30	-	-	-

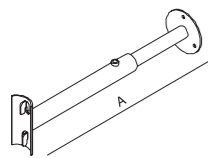

Montante a "C" per parete sospesa

C-upright for wall system unit
C-Säule für Wandstruktur
Montant à "C" pour structure murale
Montante a "C" para pared equipada



Struttura

Structure / Struktur / Structure / Estructura

CODICE	▲	A	B	C	p
RO40180	CL	-	205	-	5
RO40184	GA	-	205	-	5

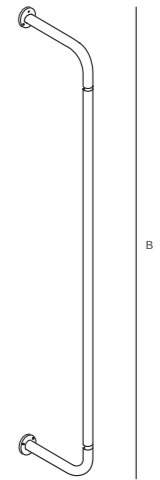

Struttura

Structure / Struktur / Structure / Estructura

CODICE	▲	A	B	C	p
RO80640	CL	70,6	150,7	79	5
RO80644	GA	70,6	150,7	79	5
RO80670	CL	104	150,7	79	5
RO80674	GA	104	150,7	79	5

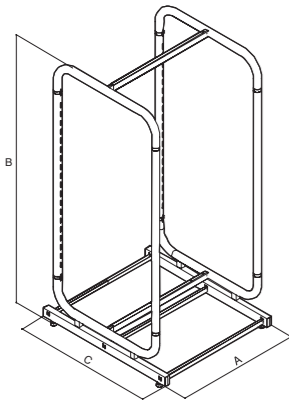

Schienale

Back panel / Panel-Rücken
Panneau de fond / Panel de fondo

CODICE	▲	A	B	C	p
RO181336307	RS	67	133,1	1,8	-
RO181336308	RM	67	133,1	1,8	-
RO181339707	RS	100	133,1	1,8	-
RO181339708	RM	100	133,1	1,8	-

Schienale di testata

Back panel for head shelving unit
Panel-Front
Panneau de fond pour tête
Panel de fondo para cabezera

CODICE	▲	A	B	C	p
RO181145907	RS	59,5	114	1,8	-
RO181145908	RM	59,5	114	1,8	-

Piano di base

Bottom shelf / Bödenplatte
Tablette de base / Estante de base

CODICE	▲	A	B	C	p
RO187863007	RS	67	79	1,8	-
RO187863008	RM	67	79	1,8	-
RO187896007	RS	100	79	1,8	-
RO187896008	RM	100	79	1,8	-

Accessori di fissaggio per schienale testata

Fixing kit for head shelving unit
Deckenbefestigung für Panel-Front
Fixation pour panneau de tête
Accesorios de fijación para panel de fondo

CODICE	▲	A	B	C	p
RO1811459	CL	-	-	-	-

Gondola con testata

Gondola with head shelving unit
Gondel, frontal
Gondole avec panneau de tête
Góndola con panel de cabezera

Gondola con doppia testata

Gondola with double head shelving unit
Gondel, beidseitig frontal
Gondole avec double panneau de tête
Góndola con panel doble de cabezera

Struttura

Structure / Struktur / Structure / Estructura

CODICE	▲	A	B	C	p
RO80340	CL	70,6	150,7	79	5
RO80344	GA	70,6	150,7	79	5
RO80370	CL	104	150,7	79	5
RO80374	GA	104	150,7	79	5

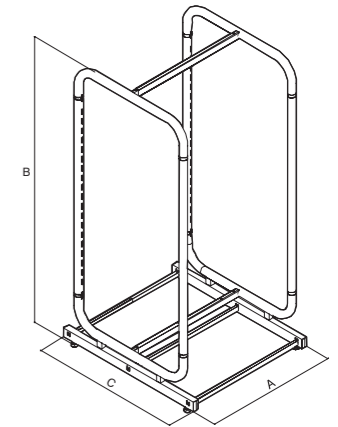

Schienale

Back panel / Panel-Rücken
Panneau de fond / Panel de fondo

CODICE	▲	A	B	C	p
RO181336307	RS	67	133,1	1,8	-
RO181336308	RM	67	133,1	1,8	-
RO181339707	RS	100	133,1	1,8	-
RO181339708	RM	100	133,1	1,8	-

Schienale di testata - 2 pz

Back panel for head shelving unit
Panel-Front
Panneau de fond pour tête
Panel de fondo para cabezera

CODICE	▲	A	B	C	p
RO181145907	RS	59,5	114	1,8	-
RO181145908	RM	59,5	114	1,8	-

Piano di base

Bottom shelf / Bödenplatte
Tablette de base / Estante de base

CODICE	▲	A	B	C	p
RO187863007	RS	67	79	1,8	-
RO187863008	RM	67	79	1,8	-
RO187896007	RS	100	79	1,8	-
RO187896008	RM	100	79	1,8	-

Accessori di fissaggio per schienale testata

Fixing kit for head shelving unit
Deckenbefestigung für Panel-Front
Fixation pour panneau de tête
Accesorios de fijación para panel de fondo

CODICE	▲	A	B	C	p
RO1811459	CL	-	-	-	-

Struttura

Structure / Struktur / Structure / Estructura

CODICE	▲	A	B	C	p
RO80660	CL	70,7	150,7	79	5
RO80664	GA	70,7	150,7	79	5
RO80100	CL	104	150,7	79	5
RO80104	GA	104	150,7	79	5

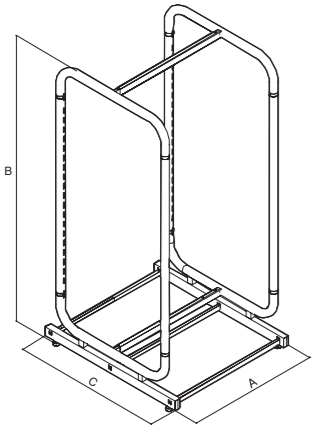

Schienale

Back panel / Panel-Rücken
Panneau de fond / Panel de fondo

CODICE	▲	A	B	C	p
RO181336307	RS	67	133,1	1,8	-
RO181336308	RM	67	133,1	1,8	-
RO181339707	RS	100	133,1	1,8	-
RO181339708	RM	100	133,1	1,8	-

Piano di base

Bottom shelf / Bodenplatte
Tablette de base / Estante de base

CODICE	▲	A	B	C	p
RO187863007	RS	67	79	1,8	-
RO187863008	RM	67	79	1,8	-
RO187896007	RS	100	79	1,8	-
RO187896008	RM	100	79	1,8	-

Gondola

Gondola
Gondel
Gondole
Góndola

Modulo Gondola

Module for Gondola
Anbau - Gondel
Module pour Gondole
Modulo Góndola

Struttura

Structure / Struktur / Structure / Estructura

CODICE	▲	A	B	C	p
RO80650	CL	66,7	150,7	79	5
RO80654	GA	66,7	150,7	79	5
RO80950	CL	100	150,7	79	5
RO80954	GA	100	150,7	79	5

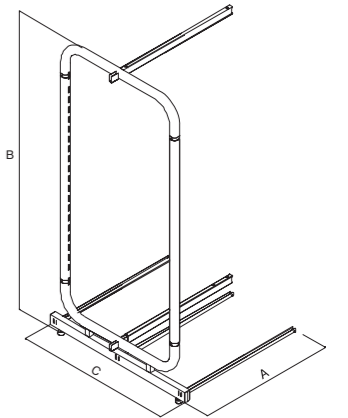

Schienale

Back panel / Panel-Rücken
Panneau de fond / Panel de fondo

CODICE	▲	A	B	C	p
RO181336307	RS	67	133,1	1,8	-
RO181336308	RM	67	133,1	1,8	-
RO181339707	RS	100	133,1	1,8	-
RO181339708	RM	100	133,1	1,8	-

Piano di base

Bottom shelf / Bodenplatte
Tablette de base / Estante de base

CODICE	▲	A	B	C	p
RO187863007	RS	67	79	1,8	-
RO187863008	RM	67	79	1,8	-
RO187896007	RS	100	79	1,8	-
RO187896008	RM	100	79	1,8	-

Accessori per pareti attrezzate e gondole

Accessories for wall system and gondola / Zubehör für Wandsystem und Gondel
Accessoires pour système murale et gondole / Accesorios para paredes y gondolas

CODICE	▲	A	B	C	p	Ø
RO25660	CL	66,6	-	-	5	-
RO25664	GA	66,6	-	-	5	-
RO25990	CL	100	-	-	5	-
RO25994	GA	100	-	-	5	-

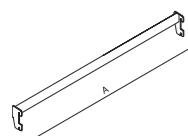

Barra porta broches
Display bar
Tragestange
Tube penderie
Barra porta-brazos



CODICE	▲	A	B	C	p	Ø
RO30660	CL	66,6	-	-	5	3
RO30664	GA	66,6	-	-	5	3
RO30990	CL	100	-	-	5	3
RO30994	GA	100	-	-	5	3

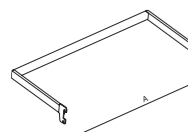

Appendiera a spalla
Hanging bar
Konfektionsrahmen
Guidons penderie
Barra colgadora



CODICE	▲	A	B	C	p	Ø
RO30640	CL	64	-	-	5	3x1,5
RO30644	GA	64	-	-	5	3x1,5

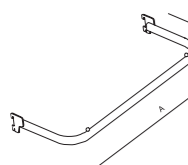

Appendiera a spalla per testata
Hanging bar for head shelving unit
Konfektionsstange für Panel-Front
Guidons penderie pour panneau de tête
Barra colgadora para cabezera



CODICE	▲	A	B	C	p	Ø
RO20640	CL	64	-	-	5	-
RO20644	GA	64	-	-	5	-

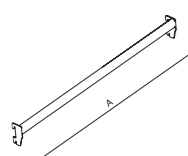

Barra porta broches per testata
Display bar for head shelving unit
Tragestange für Panel-Front
Tube penderie pour tête
Barra porta brazos para cabezera



Accessori per pareti attrezzate e gondole

Accessories for wall system and gondola / Zubehör für Wandsystem und Gondel
Accessoires pour système murale et gondole / Accesorios para paredes y gondolas

CODICE	▲	A	B	C	p	Ø
RO25550	●	CL	42	-	-	2,5
RO25554	●	GA	42	-	-	2,5
BA30550	●	CL	42	-	-	3x1,5
BA30554	●	GA	42	-	-	3x1,5

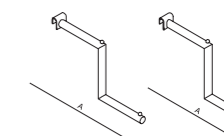

Broche a gradino sezione tonda e ovale
Stepped arm round and oval section
Abhänger, Stufe - Rundausschnitt und Ovalausschnitt
Bras à gradin, section ronde et ovale
Brazo a escadera sección redonda y ovalada



CODICE	▲	A	B	C	p	Ø
RO25360	●	CL	36	-	-	2,5
RO25364	●	GA	36	-	-	2,5
BA20360	●	CL	36	-	-	3x1,5
BA20364	●	GA	36	-	-	3x1,5

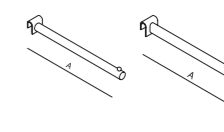

Broche dritta sezione tonda e ovale
Straight arm round and oval section
Abhänger, gerade - Rundausschnitt und Ovalausschnitt
Bras droit, section ronde et ovale
Brazo recto sección redonda y ovalada



CODICE	▲	A	B	C	p	Ø
RO25420	●	CL	45	-	-	2,5
RO25424	●	GA	45	-	-	2,5
BA30420	●	CL	45	-	-	3x1,5
BA30424	●	GA	45	-	-	3x1,5

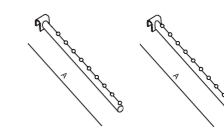

Broche inclinata a sezione tonda e ovale
Sloping arm round and oval section
Abhänger, schräg - Rundausschnitt und Ovalausschnitt
Bras incliné, section ronde et ovale
Brazo inclinado sección redonda y ovalada



CODICE	▲	A	B	C	p	Ø
BA20150	CL	15	-	-	-	0,6
BA20154	GA	15	-	-	-	0,6
BA20200	CL	20	-	-	-	0,6
BA20204	GA	20	-	-	-	0,6
BA20300	CL	30	-	-	-	0,8
BA20304	GA	30	-	-	-	0,8

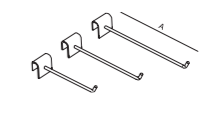

Broche in tondino
Wire bracket
Haken
Broche en fil
Gancho en hilo

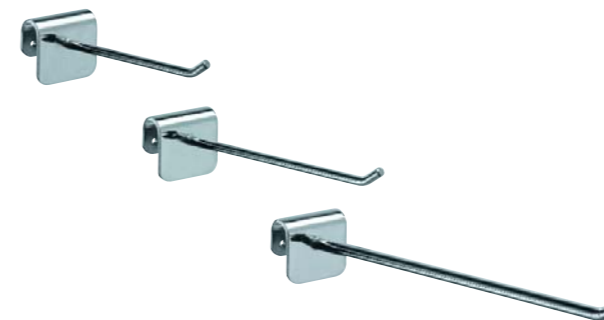

Accessori per pareti attrezzate e gondole

Accessories for wall system and gondola / Zubehör für Wandsystem und Gondel
Accessoires pour système murale et gondole / Accesorios para paredes y gondolas

CODICE	▲	A	B	C	p	Ø
BA30280	CL	12	-	-	-	-
BA30284	GA	12	-	-	-	-



Supporto busti per barra appenderia

Bust support for hanging bar
Büstenhalter für Konfektionstange
Support buste pour barre penderie
Soportes bustos para barra colgadora



CODICE	▲	A	B	C	p	Ø
RO40290	CL	28	-	-	5	-
RO40294	GA	28	-	-	5	-

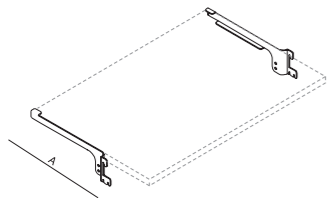

Coppia mensole

Shelf brackets
Konsole, mittig
Consoles
Cartelas



CODICE	▲	A	B	C	p	Ø
RO30650	CL	62	-	-	5	-
RO30654	GA	62	-	-	5	-
RO30970	CL	95	-	-	5	-
RO30974	GA	95	-	-	5	-

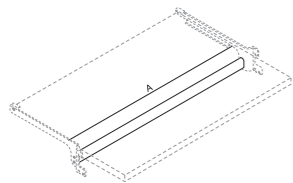

Barra appenderia per sotto-ripiano

Hanging bar for shelf
Konfektionsstange
Barre penderie avec fixation pour tablette
Barra colgadora para estante



CODICE	▲	A	B	C	p	Ø
RO23630	CL	63	23	1	5	-
RO23634	GA	63	23	1	5	-
RO23950	CL	95	23	1	5	-
RO25954	GA	95	23	1	5	-

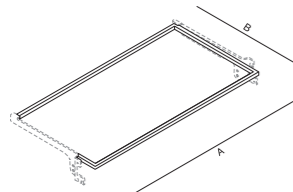

Supporto per ripiano in cristallo

Glass shelf support
Glasbödenenträger
Support pour tablette en verre
Soporte para estante en cristal



Accessori per pareti attrezzate e gondole

Accessories for wall system and gondola / Zubehör für Wandsystem und Gondel
Accessoires pour système murale et gondole / Accesorios para paredes y gondolas

CODICE	▲	A	B	C	p	Ø
GO20390	CL	39	-	-	5	-
GO20394	GA	39	-	-	5	-

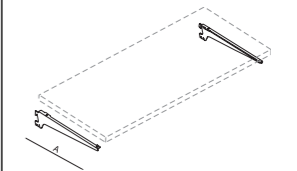

Coppia mensola per testata

Shelf brackets for head shelving unit
Konsole, frontal-Paar
Consoles pour tête
Cartelas para cabezera



CODICE	▲	A	B	C	p	Ø
RO40640	CL	64	40	1	-	-
RO40644	GA	64	40	1	-	-

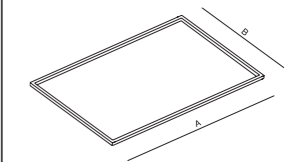

Supporto per ripiano in cristallo per testata

Glass shelf support for head shelving unit
Glasbödenenträger, frontal
Support pour tablette en verre pour panneau de tête
Soporte para estante en cristal de cabezera

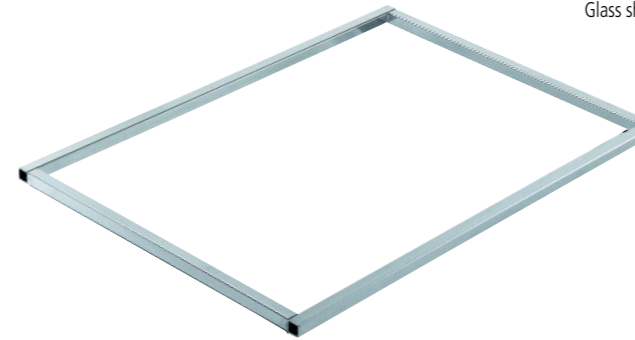

CODICE	▲	A	B	C	p	Ø
RO186240007	RS	62,2	40	1,8	-	-
RO186240008	RM	62,2	40	1,8	-	-
RO08622400	CA	62,2	40	0,8	-	-
RO189540007	RS	95,6	40	1,8	-	-
RO189540008	RM	95,6	40	1,8	-	-
RO08956400	CA	95,6	40	0,8	-	-

Ripiani
Shelves
Böden
Tablettes
Estantes



CODICE	▲	A	B	C	p	Ø
RO186440007	RS	64	40	1,8	-	-
RO186440008	RM	64	40	1,8	-	-
RO08640400	CA	64	40	0,8	-	-

Ripiani per testata

Shelves for head shelving unit
Böden für Panel-Front
Tablettes pour tête
Estantes para cabezera



Accessori per ripiani di testata

Accessories for head shelving unit
Zubehör für Panel-Front
Accessoires pour tablettes pour tête
Accesorios para estantes para cabezera

CODICE	VITI PER TRUCIOLARE
41009	Screw for chipboards Schrauben für Spanplatten Vis pour panneaux agglomérés Tornillos para conglomerado

Compositions - Kombinationen
Composicions - Composiciones

CODICE	▲	A	B	C
RO6010007	CL / RS	103,7	150	60
RO6010008	CL / RM	103,7	150	60
RO6010407	GA / RS	103,7	150	60
RO6010408	GA / RM	103,7	150	60

Struttura

Structure / Struktur / Structure / Estructura

CODICE	▲	A	B	C	p
RO60100	CL	103,7	150	60	5
RO60104	GA	103,7	150	60	5

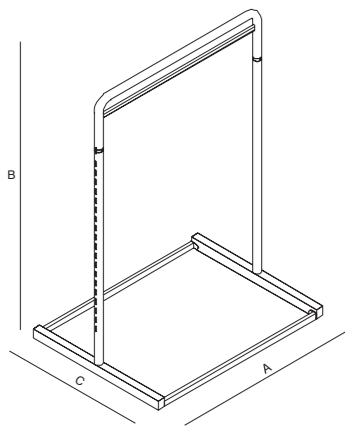

Piano di base

Bottom shelf / Bödenplatte
Tablette de base / Estante de base

CODICE	▲	A	B	C	p
RO189560007	RS	100	60	1,8	-
RO189560008	RM	100	60	1,8	-

Stender Rondò

Rondò rail
Rondò Ständer
Penderie Rondò
Perchero Rondò



Accessori stender

Rondò rail accessories / Rondò Ständer Zubehör
Accessoires penderie Rondò / Accesorios perchero Rondò

Pianetto dritto 30 x 30 cm

Straight shelf
gerade Ablage
Tablette droite
Estante recto

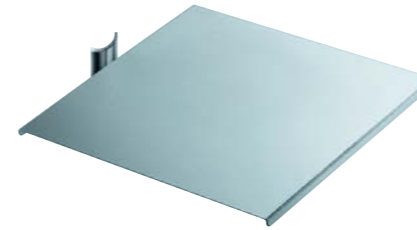

CODICE	▲	A	B	C	s
RO403030	CL	30	-	30	5
RO403034	GA	30	-	30	5

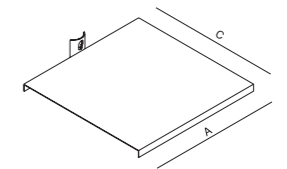

Pianetto inclinato 35 x 30 cm

Sloping shelf
schräge Ablage
Tablette inclinée
Estante inclinado



CODICE	▲	A	B	C	s
RO403530	CL	30	-	35	5
RO403534	GA	30	-	35	5

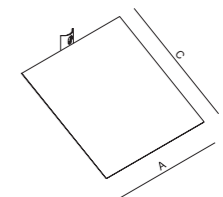

Pianetto portascarpe 12 x 25 cm

Shoe shelf
Schuhablage
Tablette chaussures
Estante porta zapatos

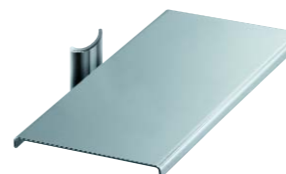

CODICE	▲	A	B	C	p
RO401250	CL	25	-	12	5
RO401254	GA	25	-	12	5

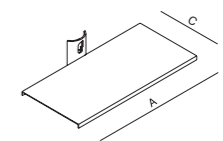

Broche a gradino con aggancio tondo

Stepped arm with round hook
Stufenabhängiger
Bras à gradin avec fixation ronde
Brazo a escalera con enganche redondo



CODICE	▲	A	B	C	p
RO40550	CL	40	-	-	5
RO40554	GA	40	-	-	5

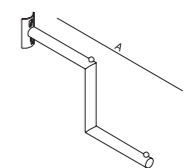

Broche dritta con aggancio tondo

Straight arm with round hook
Abhängiger, gerade
Bras droit avec fixation ronde
Brazo recto con enganche redondo



CODICE	▲	A	B	C	p
RO40360	CL	36	-	-	5
RO40364	GA	36	-	-	5

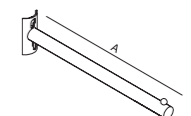

Compositions - Kombinationen
Composicions - Composiciones

CODICE	▲	A	B	C
RO6011007	CL / RS	104	164	60
RO6011008	CL / RM	104	164	60
RO6011407	GA / RS	104	164	60
RO6011408	GA / RM	104	164	60

Struttura

Structure / Struktur / Structure / Estructura

CODICE	▲	A	B	C	p
RO60110	CL	104	164	60	5
RO60114	GA	104	164	60	5

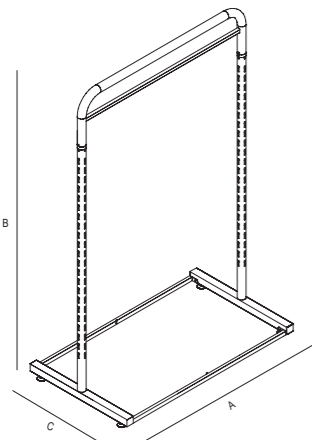

Schienale

Back panel / Rückenteil
Panneau de fond / Panel de fondo

CODICE	▲	A	B	C	p
RO181309407	RS	94,9	130	1,8	-
RO181309407	RM	94,9	130	1,8	-

Piano di base

Bottom shelf / Bödenplatte
Tablette de base / Estante de base

CODICE	▲	A	B	C	p
RO189560007	RS	95,5	60	1,8	-
RO189560008	RM	95,5	60	1,8	-

Accessori di fissaggio

Fixing kit / Deckenbefestigung
Fixation / Accesorios de fijación

CODICE	▲	A	B	C	p
RO600110500	CL	-	-	-	-
RO600110504	GA	-	-	-	-

Gondolina Rondò

Gondolina Rondò
Gondolina Rondò
Gondolina Rondò
Gondolina Rondò



Accessori gondolina

Gondolina rail accessories / Gondolina Ständer Zubehör
Accessoires penderie gondolina / Accesorios perchero gondolina

Pianetto dritto 30 x 30 cm

Straight shelf
gerade Ablage
Tablette droite
Estante recto

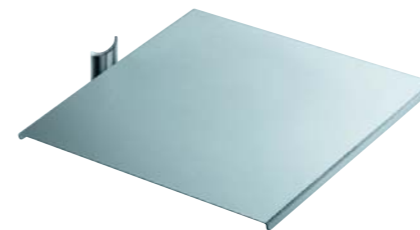

CODICE	▲	A	B	C	s
RO403030	CL	30	-	30	5
RO403034	GA	30	-	30	5

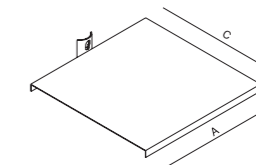

Pianetto inclinato 35 x 30 cm

Sloping shelf
schräge Ablage
Tablette inclinée
Estante inclinado



CODICE	▲	A	B	C	s
RO403530	CL	30	-	35	5
RO403534	GA	30	-	35	5

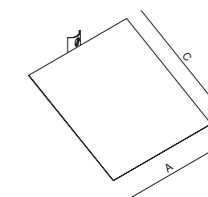

Pianetto portascarpe 12 x 25 cm

Shoe shelf
Schuhablage
Tablette chaussures
Estante porta zapatos

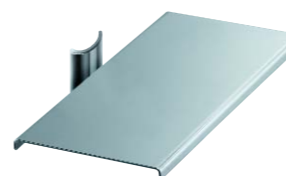

CODICE	▲	A	B	C	p
RO401250	CL	25	-	12	5
RO401254	GA	25	-	12	5

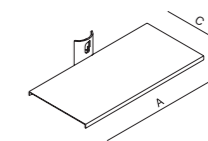

Broche a gradino con aggancio tondo

Stepped arm with round hook
Stufenabhängiger
Bras à gradin avec fixation ronde
Brazo a escalera con enganche redondo



CODICE	▲	A	B	C	p
RO40550	CL	40	-	-	5
RO40554	GA	40	-	-	5

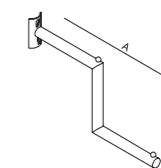

Broche dritta con aggancio tondo

Straight arm with round hook
Abhängiger, gerade
Bras droit avec fixation ronde
Brazo recto con enganche redondo



CODICE	▲	A	B	C	p
RO40360	CL	36	-	-	5
RO40364	GA	36	-	-	5

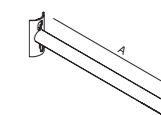

Accessori gondolina

Gondolina rail accessories / Gondolina Ständer Zubehör
Accessoires penderie gondolina / Accesorios perchero gondolina

CODICE	▲	A	B	C	p	Ø
BA25990	CL	100	25	-	5	3x1,5
BA25994	GA	100	25	-	5	3x1,5

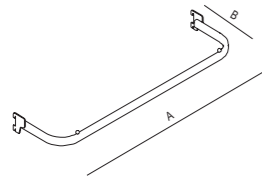

Appendiera a spalla

Straight hanging rail
Konfektionsrahmen
Guidons penderie
Barra colgadora



CODICE	▲	A	B	C	p	Ø
BA20990	CL	100	-	-	5	3x1,5
BA20994	GA	100	-	-	5	3x1,5

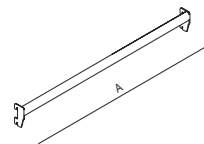

Barra porta broches

Display bar
Tragestange
Barre de charge
Barra porta-brazos



CODICE	▲	A	B	C	p	Ø
RO25550	●	CL	42	-	-	2,5
RO25554	●	GA	42	-	-	2,5
BA30550	●	CL	42	-	-	3x1,5
BA30554	●	GA	42	-	-	3x1,5

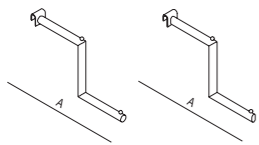

Broche a gradino sezione tonda e ovale

Stepped arm round and oval section
Abhänger, Stufe - Rundausschnitt und Ovalausschnitt
Bras à gradin, section ronde et ovale
Brazo a escalera sección redonda y ovalada



CODICE	▲	A	B	C	p	Ø
RO25360	●	CL	36	-	-	2,5
RO25364	●	GA	36	-	-	2,5
BA20360	●	CL	36	-	-	3x1,5
BA20364	●	GA	36	-	-	3x1,5

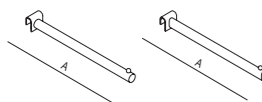

Broche dritta sezione tonda e ovale

Straight arm round and oval section
Abhänger, gerade - Rundausschnitt und Ovalausschnitt
Bras droit, section ronde et ovale
Brazo recto sección redonda y ovalada



CODICE	▲	A	B	C	p	Ø
RO25420	●	CL	45	-	-	2,5
RO25424	●	GA	45	-	-	2,5
BA30420	●	CL	45	-	-	3x1,5
BA30424	●	GA	45	-	-	3x1,5

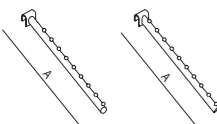

Broche inclinata sezione tonda e ovale

Sloping arm round and oval section
Abhänger, schräg - Rundausschnitt und Ovalausschnitt
Bras incliné, section ronde et ovale
Brazo inclinado sección redonda y ovalada



Accessori gondolina

Gondolina rail accessories / Gondolina Ständer Zubehör
Accessoires penderie gondolina / Accesorios perchero gondolina

Supporto busti per barra appendiera

Bust support for hanging bar
Büstenhalter für Konfektionsrahmen
Support buste pour barre penderie
Soportes bustos para barra colgadora



CODICE	▲	A	B	C	p	Ø
BA30280	CL	12	-	-	-	-
BA30284	GA	12	-	-	-	-

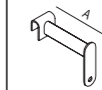

Supporto per ripiano in cristallo

Glass shelf support
Kristallbödenträger
Support pour tablette en glace
Soporte para estante en cristal

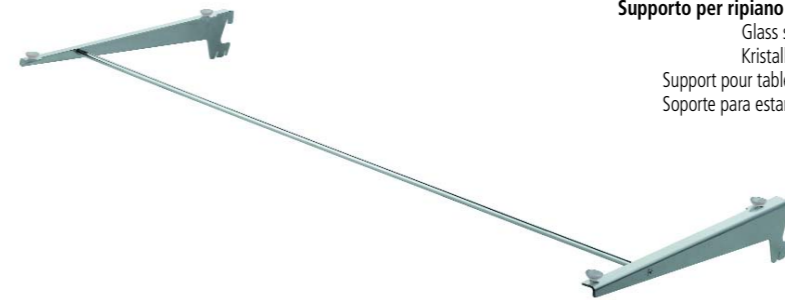

CODICE	▲	A	B	C	p	Ø
GO2039020	CL	100	40	-	-	-
GO2039024	GA	100	40	-	-	-

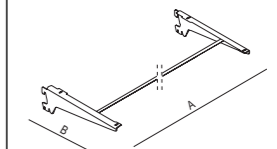

Coppia mensole

Shelf brackets (pair)
Konsole - Paar
Consoles (la paire)
Cartelas



CODICE	▲	A	B	C	p	Ø
GO20390	CL	40	-	-	5	-
GO20394	GA	40	-	-	5	-

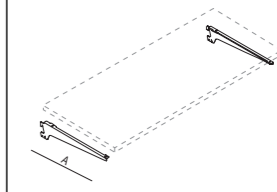

Ripiani

Shelves
Böden
Tablettes
Estantes



CODICE	▲	A	B	C	p	Ø
GO20099407	RS	97	40	1,8	-	-
GO20099408	RM	97	40	1,8	-	-
GO208379900	CA	97	40	0,8	-	-

Compositions - Kombinationen
Composicions - Composiciones

CODICE		A	B	C
R09569007	CL / CT / RS	146	95,3	69
R09569008	CL / CT / RM	146	95,3	69
R09569010	CL / CT / CA	146	95,3	69
R09569407	GA / CT / RS	146	95,3	69
R09569408	GA / CT / RM	146	95,3	69
R09569410	GA / CT / CA	146	95,3	69

Struttura

Structure / Struktur / Structure / Estructura

CODICE		A	B	C	p
R095690	CL	146	93,5	69	-
R095694	GA	146	93,5	69	-

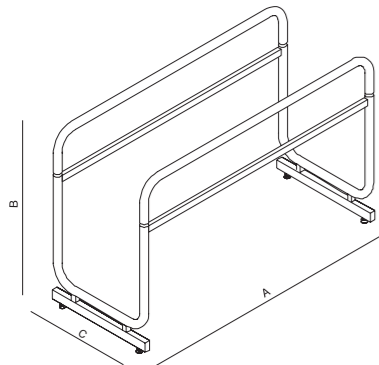

Piano

Shelf / Böden / Tablette / Estante

CODICE		A	B	C	p
EV137007	RS	137,8	69,9	1,8	-
EV137008	RM	137,8	69,9	1,8	-
VS350M137000	CA	137	69	0,8	-
VS350M137005	CT	137	69	0,8	-

Banco espositivo

Display table
Vorlagentisch
Comptoir
Mostrador



Seduta in ecopelle

Stool, synthetic leather
Hocker aus synthetischem Leder
Tabouret en cuir
Taburete simil piel



Compositions - Kombinationen
Composicions - Composiciones

CODICE		A	B	C
R04564009	CL / B	65	43	45
R04564011	CL / R	65	43	45
R04564409	GA / B	65	43	45
R04564411	GA / R	65	43 <td 45	

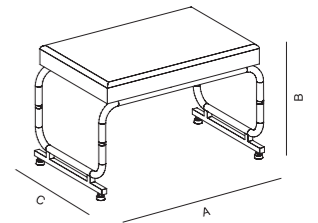

Imballo
Packaging
Verpackung
Emballage
Embalaje

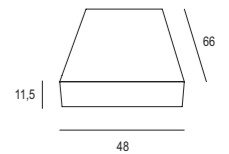

Colori sedute

Seat finishing / Sitz-Farben
Couleurs assises / Colores de asientos

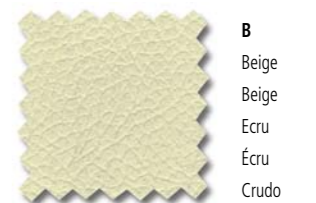
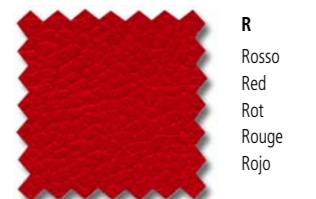

tavolini

composizioni

Compositions - Kombinationen
Composizioni - Composiciones

h 80 cm

CODICE	●	A	B	C
R07340007	CL / RS	95	80	40
R07340008	CL / RM	95	80	40
R07340010	CL / CA	95	80	40
R07340407	GA / RS	95	80	40
R07340408	GA / RM	95	80	40
R07340410	GA / CA	95	80	40

h 60 cm

CODICE	●	A	B	C
R05340007	CL / RS	95	60	40
R05340008	CL / RM	95	60	40
R05340010	CL / CA	95	60	40
R05340407	GA / RS	95	60	40
R05340408	GA / RM	95	60	40
R05340410	GA / CA	95	60	40

h 40 cm

CODICE	●	A	B	C
R03340007	CL / RS	95	40	40
R03340008	CL / RM	95	40	40
R03340010	CL / CA	95	40	40
R03340407	GA / RS	95	40	40
R03340408	GA / RM	95	40	40
R03340410	GA / CA	95	40	40

Struttura

Structure / Struktur / Structure / Estructura

CODICE	●	A	B	C	p
h 80 cm R073400	CL	95	78	40	
R073404	GA	95	78	40	
h 60 cm R053400	CL	95	58	40	
R053404	GA	95	58	40	
h 40 cm R033400	CL	95	38	40	
R033404	GA	95	38	40	

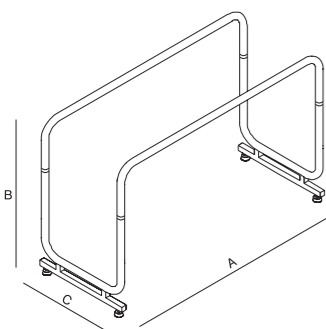

Piano

Shelf / Böden / Tablette / Estante

CODICE	●	A	B	C	p
EV904007	RS	90	40	1,8	
EV904008	RM	90	40	1,8	
G0089040	CA	90	40	0,8	

Tavolini

Display tables
Vorlagentische
Tables de présentation
Mesas de exposición



h 80 cm



h 60 cm



h 40 cm

